

Wireless Data Logging System

RTR-500 Series



Process and Manage your Important Data
Anytime from Anywhere

T&D Corporation



Still Collecting Data One by One?

T&D can change that...Get All Your Data Just by Opening the Internet!

What is a T&D Wireless Data Logging System?

Measure / Record

Collect / Send

Monitor / Manage

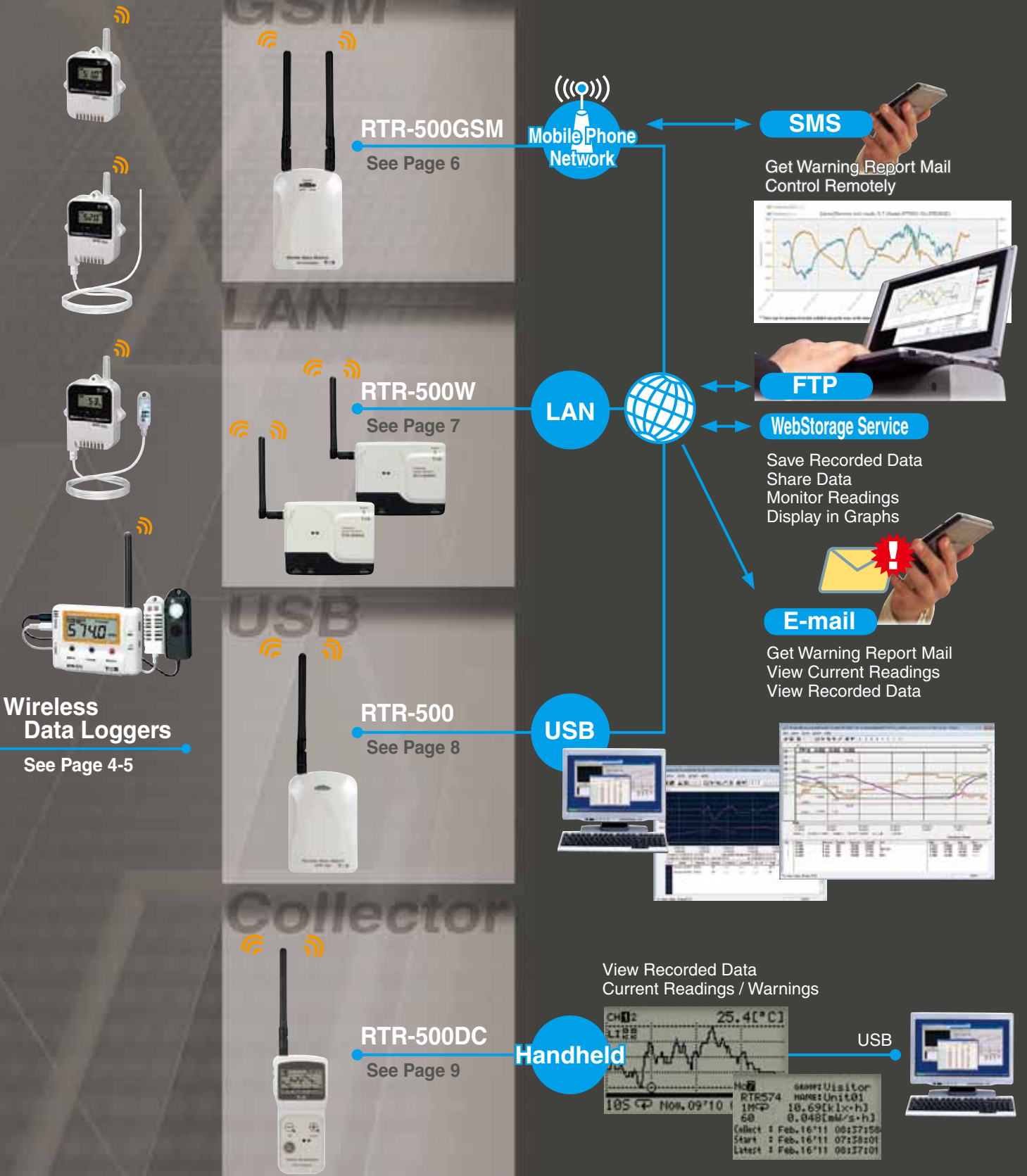

Remote Units and Base Units: What are they and what can they do?

Remote Units are Data Loggers that can measure and record data such as temperature and humidity. Base Units use wireless communication to collect the data recorded and saved in the Remote Units. Also, Base Units can be set up to periodically communicate with Remote Units to monitor for measurement abnormalities and other warnings. This collected data, as well as, current readings can be sent via FTP or E-mail to a specified location. Moreover, upon a warning occurrence warning reports can be sent via E-mail.

Select the Type of Data Logger and Base Station to Fit your Needs

Mobile Base Station RTR-500GSM with its built-in cellular phone communication capability is perfect for use in remote areas where a LAN connection is difficult or not available. The Network Base Station RTR-500W is designed as a Base Unit for use with a LAN connection and is perfect for use in places where no PC is available or as a quick addition to a network to create a measurement management system. The Wireless Base Station RTR-500 is an easy-to-use Base Unit for onsite use with a USB connection to a local computer. The handheld Wireless Data Collector RTR-500DC is a user-friendly wireless communication Data Collector designed for hand-held portability. The type of Data Logger can be selected to match your measurement items and range. And to further increase the possibilities, an array of optional sensors is also available.

High Speed Wireless Communication and Data Downloading

The RTR-500 Series is designed for powerful and reliable wireless communication. The wireless communication range, if unobstructed and direct, is about 150 meters (500 ft). It takes only about two minutes to download data from one Remote Unit at full capacity. The Loggers have been designed to keep on working in even harsh conditions; that is why wireless communication is still possible in conditions from minus 30°C to 80°C.

* Note: This is the range of temperature in which wireless communication is possible and does not represent the measurement range of Remote Units, nor the range in which Remote Units or Base Units can be operated.

Easy Expansion of the Wireless Communication Range

It is possible to expand the wireless communication range by simply registering a Repeater (RTR-500) or a number of Repeaters to relay communication between a Base Unit and Remote Units.

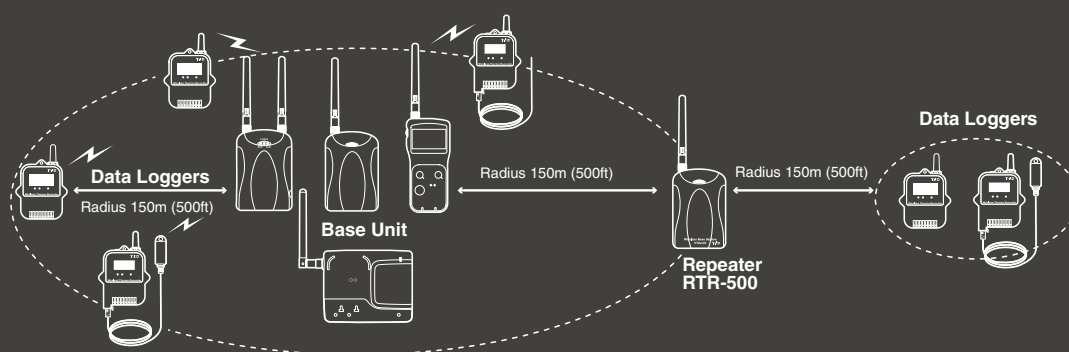

One Base Unit for Total Management of Multiple Remote Units

With just one Base Unit it is possible to simultaneously manage a large number of Remote Units. Groups of Remote Units and Repeaters can be created and registered to a Base Unit to match your situation: by location, by item, by user and so on. Each Group is assigned a Wireless Communication Frequency Channel to avoid interference and poor transmission.

Base Unit Type	Remote Units	Groups	Repeaters
RTR-500GSM	Total of 20	4	5 Per Group
RTR-500NW / RTR-500AW	Total of 100	10	10 Per Group
RTR-500	32 Per Group	20	30 Per Group
RTR-500DC	32 Per Group, 16 Per Group (RTR-574)	7	15 Per Group





Dedicated Software Free of Charge

RTR-500 Series software is provided free of charge to our customers. This dedicated software makes settings a snap: from registration of Base Units, Remote Units and Repeaters to wireless and network communication settings.

Monitoring of Current Readings via a Web Browser (T&D WebStorage Service)

By sending the collected data to our online service "T&D WebStorage Service", it is possible to monitor current readings and/or warnings, as well as, share the data via a PC web browser. "T&D Webstorage Service" (<http://www.webstorage-service.com/>) is a free web-based storage service provided by T&D Corporation.

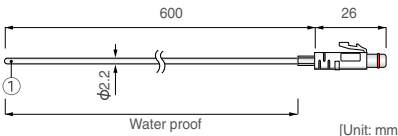
RTR-501/502/503: Data Loggers Built to Work and Last in Harsh Environments

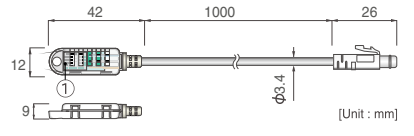
<p>RTR-501 / 501L</p>  <p>Measurement Range -40 to 80°C</p> <p>Water Resistance Immersion proof Not submersible</p> <hr/> <p>Temperature Sensor Internal Temperature Sensor</p>	<p>RTR-502 / 502L External Temperature Sensor Included</p>  <p>Measurement Range -60 to 155°C</p> <p>Water Resistance Splash proof (rated for use in daily life when the sensor is connected. Not for continued immersion.</p> <hr/> <p>Temperature Sensor TR-5106</p>  <p>Water Resistance: The fluoropolymer-coated section is waterproof. Other sections are immersion proof ① Thermistor Area</p>	<p>RTR-503 / 503L External Temperature / Humidity Sensor Included</p>  <p>Measurement Range Temperature : -0 to 55°C Humidity: 10 to 95%RH</p> <p>Water Resistance Splash proof (rated for use in daily life when the sensor is connected. Not for continued immersion.</p> <hr/> <p>Temperature / Humidity TR-3310</p>  <p>Water Resistance: None ① Temp/Humidity Sensor Area</p>
---	---	--

RTR-501: Durable Waterproof and Dustproof Body

The RTR-501 with internal sensor provides optimum waterproof and dustproof capabilities. This is the perfect Data Logger for use in harsh environments: whether that may be indoor frozen or refrigerated storage or high humidity, high dust outdoor applications. Moreover, the compact lightweight design means it can be placed just about anywhere.

RTR-502: Variety of Optional Sensors for Wide Range Measurement

We offer a variety of optional sensors to meet your needs; from ones with stainless protection to those that can be used in water. For details see the Optional Sensors page.

RTR-503: For Temperature and Humidity

The RTR-503 uses a sensor that measures and records both temperature and humidity.

Note: The attached sensor TR-3310 is not waterproof.

Large Logging Capacity: Up to 16,000 readings

16,000 readings means you can record every one second and still log four and a half hours of data; or at a recording interval of 60 minutes you can keep logging for 666 days. By using the software the recording interval for a Remote Unit can be set to one out of fifteen choices (1 second to 60 minutes).

RTR-501/502:

The maximum number of data readings that can be stored in one Data Logger is 16,000.

RTR-503:

The maximum number of data readings that can be stored in one Data Logger is 8,000 data sets. One data set consists of readings for all channels in that type of unit.

Recording Mode (Endless / One Time)

Select the Recording Mode from Endless or One Time. When using Endless Mode, upon reaching the logging capacity the oldest data is overwritten and recording continues. When using One Time, upon reaching logging capacity recording automatically stops.

Low Energy Consumption Design means Longer Continuous Operation

The Data Loggers are outfitted with a long lasting Lithium Battery (LS14250). At normal temperature, if recorded data is downloaded once a day or if monitoring is carried out once every ten minutes, the estimated battery life will be about ten months. Model names which include "L" are designed with a large capacity battery pack. Under the same conditions, L-type models will continue for about four years without the need to change the battery.

Note: * Lithium batteries (CR2) sold in stores may also be used, but only in temperatures between -20°C and 60°C. If you are using a Logger in an environment where temperatures may be lower than -20°C or higher than 60°C, we strongly suggest purchasing and using the "Optional Battery Set" (TR-11P2).

* Battery life varies depending upon the type of battery, the measuring environment, the frequency of communication, and the ambient temperature in which it is used. All estimates are based on operations carried out with a new battery and are in no way a guarantee of actual battery life.

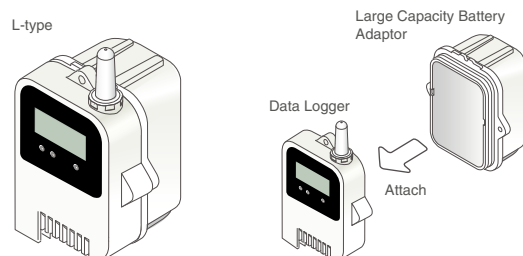

Possible to Adjust Measurements

An Adjustment Function has been included to aid in the adjustment of measurements. This function can be set up using the "Adjustment Tools" application in the software supplied with the Base Unit.

RTR-574: One Logger records Illuminance, UV, Temperature and Humidity

RTR-574

External UV and Illuminance Sensor / Internal Temperature and Humidity Sensor



Measurement Range

Illuminance: 0 ~ 130,000 lx·h
 UV Intensity: 0 ~ 30W/cm²h
 Temperature : -0 ~ 55°C
 Humidity: 10 ~ 95%RH

Water Resistance

None

Note: * Currently, this product is not compatible with RTR-500GSM

Illuminance UV Sensor ISA-3151

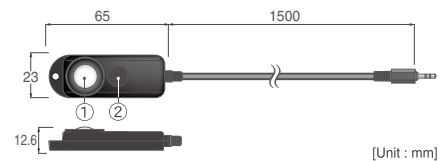

Water Resistance: None
 ① Illuminance Sensor Area ② Ultraviolet Sensor Area

Temperature Humidity Sensor THA-3151

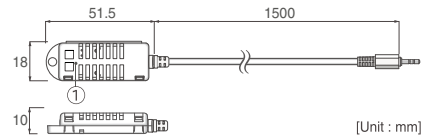

Water Resistance: None
 ① Temperature/Humidity Sensor Area

View Recording Status on Easy-to-Read Display

The large display allows you to easily check the RTR-574's recording status, battery status and remaining data capacity as well as all types of measurements.



- ① This mark comes ON when recording is in progress
- ② Scale shows the amount of stored data. A block is added for every 2000 readings.
- ③ Communication status is shown here
- ④ Current Recording Mode (ENDLESS or ONETIME) is shown here
- ⑤ This mark shows when it is time to replace battery

View Cumulative Values

Besides measuring and recording Illuminance, UV, Temperature and Humidity, the RTR-574 calculates and displays the "Cumulative Illuminance" and "Cumulative Amount of UV Light" during a recording session.

Cumulative Illuminance Display Range: 0 to 90,000,000 lxh
 Cumulative Amount of Ultraviolet Light Display Range: 0 to 62W/cm²h

Note: *The cumulative values are for display only. They are not recorded.

Simple, Direct USB Connection

It is possible to connect an RTR-574 Unit directly to your computer with a USB cable. Data can be quickly and easily downloaded to your PC. If the computer has more than one USB port, it is possible to connect multiple RTR-574 Units to one computer at the same time.

Note: *This is not possible if your operating system is Windows XP.

Logging Capacity: 8,000 data sets

Up to 8,000 data sets can be stored in one logger. One data set consists of readings for all channels in that type of unit: Illuminance, UV intensity, Temperature, and Humidity.

Recording Mode (Endless / One Time)

Select the Recording Mode from Endless or One Time. When using Endless Mode, upon reaching the logging capacity the oldest data is overwritten and recording continues. When using One Time, upon reaching logging capacity recording automatically stops.

Illuminance Measurable in Wide Range

The Illuminance measurement range is from 0 to 130,000 lx; which means it is possible to measure in both dim moonlight and the bright summer sun. And with recording and display possible at a resolution down to 0.01 lx, measurements can be taken in conditions of even less light.

Button Operation Possible

The buttons on the face of the RTR-574 Unit make it possible to change the LCD display pattern, start and stop recording, make or change recording interval settings, and turn power ON or OFF. To prevent unexpected errors in button operation, you can use the software supplied with the Base Unit to lock the button operation.

DISPLAY Button

The RTR-574 display can be changed as follows: Illuminance (lx, Klx) >> UV Intensity (mW/cm²) >> Temperature(°C, °F) >> Humidity (%) >> Cumulative Illuminance (lxh, Klxh, Mlxh) >> Cumulative Amount of Ultraviolet Light (mW/cm²h, W/cm²h) >> Back to the Alternate Display. By pressing the Display Button it is possible to switch between continually viewing all items in a cycle or select only certain items for view.

INTERVAL Button

Use this button to check the current Recording Interval and make any necessary changes to it.

REC/STOP Button

Use this to start and stop recording.

Up to Four Months of Operation on One Battery

Power is provided by one AA alkaline battery. If one RTR-574 at full logging capacity is downloaded once a day via wireless communication, the estimated battery life is about four months.

Note: * Battery life varies depending upon the type of battery, the measuring environment, the frequency of communication, and the ambient temperature in which it is used. All estimates are based on operations carried out with a new battery and are in no way a guarantee of actual battery life.
 *There are no L-types models of RTR-574.

Possible to Adjust Measurements

An Adjustment Function has been included to aid in the adjustment of measurements. This Function can be set up with the "Adjustment Tools" application in the software supplied with the Base Unit.

Base Unit equipped with GSM Cellular Phone Network Capabilities

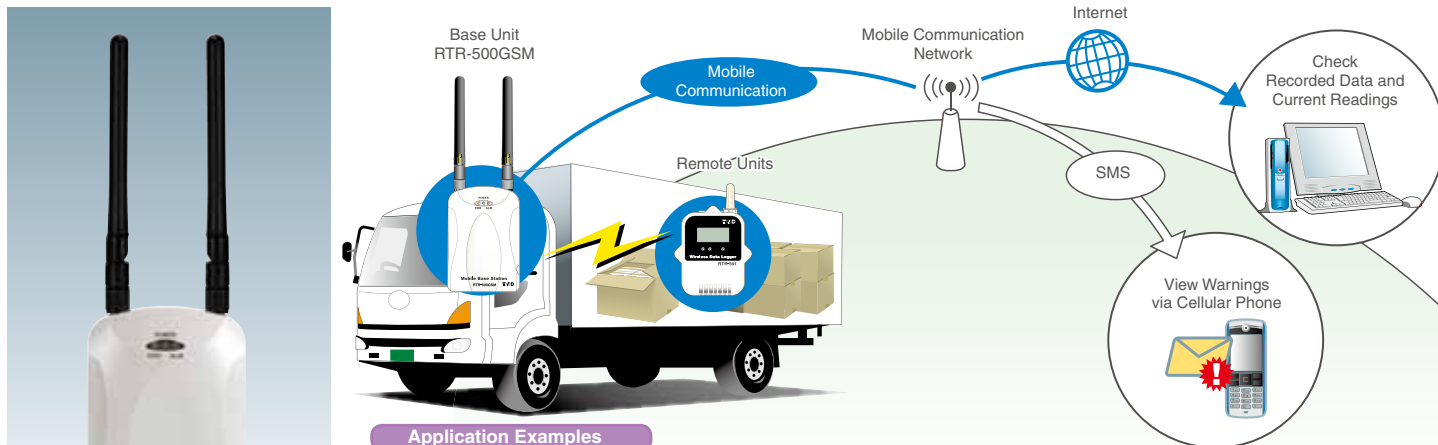

Application Examples

- *Place in freight vehicle to record and monitor temperature and humidity during transport
 - *Monitoring and recording temperature and humidity in distant places where LAN connection is impossible
 - *Monitoring and recording temperature and humidity in buildings where a LAN connection is impossible or not preferred.
- Note:** Currently the RTR-500GSM and RTR-574 are not compatible.

GSM Cellular Phone Communication Function

The RTR-500GSM operates using a SIM card from your cellular phone company or carrier. As long as you are in communication range for cellular phone service, simply place a Base Unit in the truck cabin and Remote Unit(s) in the cargo compartment(s) and you are ready to monitor temperature and humidity while on the move. Perfect for in the mountains, on the sea or for any out of the way places where a LAN connection is impossible.



Warning Monitoring Function

If any of the parameters set in the RTR-500GSM are exceeded and the RTR-500GSM judges that to be "Warning Occurrence" a warning report mail can be sent via e-mail or SMS (short messaging service). Moreover, by connecting a siren or lamp to the external contact input / output connector when an important warning occurs, the people at the point of measurement can also quickly take any necessary action.

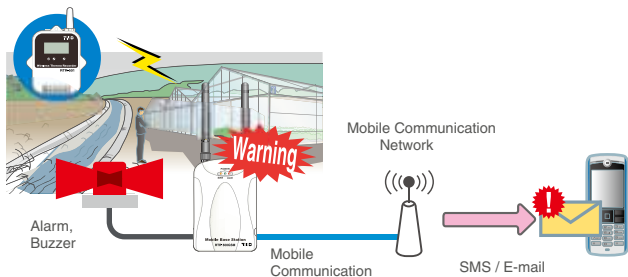

Automatically Download and Send Data

At the set interval, the Base Unit will communicate with the target Remote Unit(s) and collect recorded data or current readings and send the received data via FTP or e-mail.

Control Operation via SMS Commands

Via SMS commands from a cell phone to the RTR-500GSM, it is possible to start and stop RTR-500 GSM operation. It is also possible to request recorded data be downloaded to a set address.

High Speed Wireless Communication and Data Downloading

The wireless communication range, if unobstructed and direct, is about 150 meters (500ft). Downloading recorded data from one Remote Unit at full capacity (16,000 data sets) into the Base Station takes only about 2 minutes. The wireless communication range can be easily expanded by placing a Repeater in between the RTR-500GSM and a Remote Unit. When downloading recorded data, it is necessary to add 2 minutes (when at full capacity) for every Repeater in the route.

Select a Power Source to meet your Application Needs

The user can select to run the unit on four AA alkaline batteries, or use the AC adaptor to connect to an AC outlet, or hook up to an external power source of their choice by connecting to the External Power Connector (DC 8- 34V). Keeping batteries in the unit allows a backup source of power for when and if electrical power is cut from the AC or DC connection. If using batteries as the source of power, the estimated battery life is about 10 days.

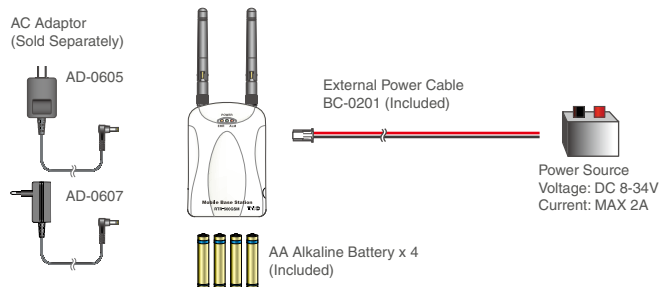

- Note:**
- * If necessary, please purchase separately our optional AC adaptor AD-0605 / AD-0607.
 - * When using an external power source, it is necessary to use a power source which meets the specifications of our External Power Cable BC-0201 supplied with the unit. We do not handle or sell external power sources; please purchase separately.
 - * Battery Life will vary depending on the measuring environment, the quality of the battery being used, the frequency of communication and other settings made in the unit.

Simultaneous Management of Multiple Remote Units

Up to 4 Groups can be registered to an RTR-500GSM. With just one RTR-500GSM it is possible to simultaneously manage up to 20 Remote Units.

Attach GPS Info to Current Readings (Optional)

Current Readings from Remote Unit(s) can be sent via e-mail or FTP; with a GPS receiver connected current location info can also be attached to the transmission.

- Note:** T&D Corporation does not handle or sell GPS receivers. The following receiver has been proven to work with our system: BR-355 Cable GPS (GlobalSat Corporation). For all inquires and questions concerning sales of the product, please directly contact GlobalSat at (<http://www.globalsat.com.tw>).

Base Unit for LAN Connection : Wired or Wireless

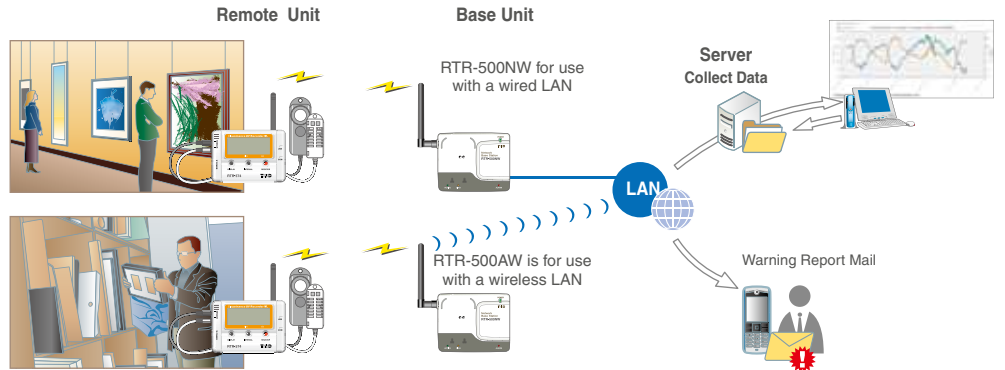

Application Examples

- * For centralized monitoring and management of temperature and humidity in refrigerated cases across supermarkets or other chain stores
- * For monitoring systems of pharmacy storage facilities
- * For degradation prevention systems in art museums and other archival and exhibit forums

Automatically Download and Send Data

At the set interval, the RTR-500W will communicate via wireless communication to collect recorded data or current readings from Remote Units and send the received data via FTP, e-mail to a set address or send it to our "T&DWebStorage Service".

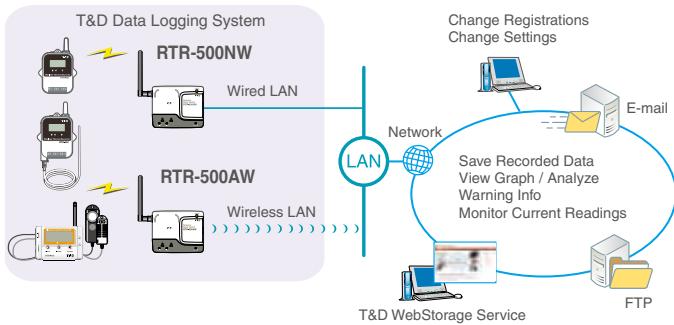

Register Remote Units and Change Settings via the Network

After having made initial settings you wish to add a new Remote Unit or change the registration info of a Remote Unit, it can be done easily by sending the settings info to the RTR-500W over the network. There is no need to retrieve the RTR-500W from its location to make these changes.

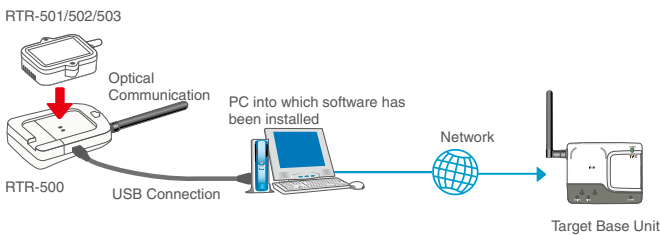

Note: * If you wish to add an RTR-501/502/503 Remote Unit via the network it is necessary to have an RTR-500 unit to which you can connect to the PC.

An Array of Warning Monitoring Functions

If and when a measurement exceeds the set Upper or Lower Limit or if an abnormality occurs in the Remote Unit the RTR-500W will go into "Warning" mode whereby the ALARM LED and the external contact output will be switched ON. In addition, a warning report e-mail can be sent.

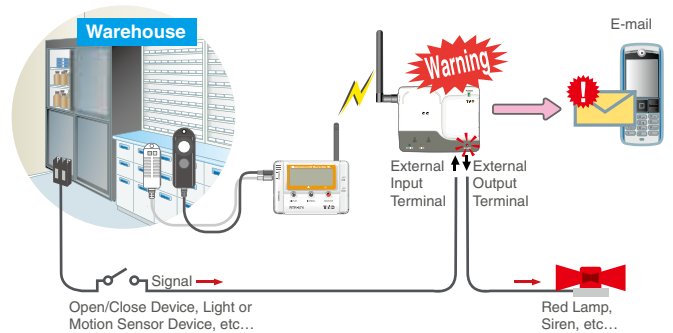

ALARM LED Lamp

The ALARM LED lamp on the RTR-500NW/500AW will come on.

Warning Report Mail

A warning report mail will be sent to the specified e-mail address(es).

External Contact Output (Warning Output)

In conjunction with the ALARM LED the external contact output will switch to ON. It is possible to create an effective warning system by connecting a siren, light or other easily understandable warning device to the external output terminal.

External Contact Input

By connecting a surveillance system sensor such as a motion sensor, light sensor, or open/close sensor to the external input terminal it is possible to detect an external electronic signal (ON /OFF). When an ON signal is detected a warning report mail can be sent.

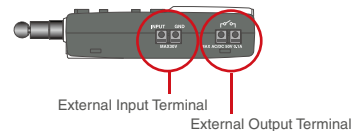

Simultaneous Management of Multiple Remote Units

Up to 10 groups can be registered to one RTR-500W Base Unit. Each RTR-500NW or RTR-500AW can simultaneously manage up to 100 Remote Units.

Register as a Base Station or a Repeater

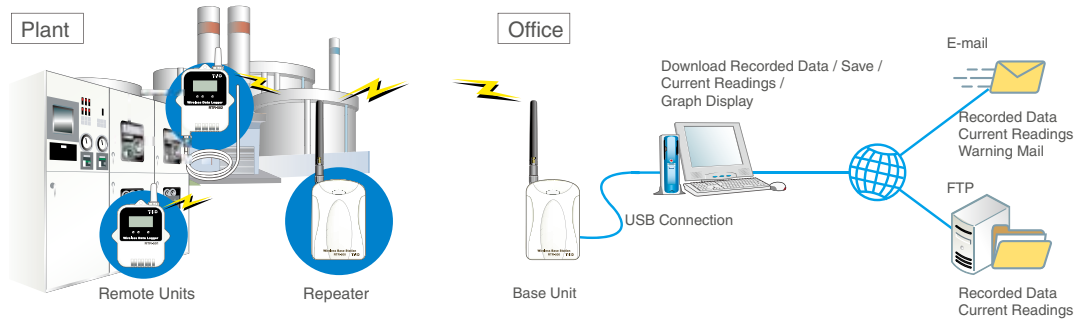

Application Examples

- * For recording and monitoring temperature and humidity in factories and buildings
- * For temperature and humidity management in blood and pharmaceutical storage at hospitals
- * For temperature management of refrigerated and frozen goods at supermarkets and convenience stores
- * For management of illuminosity to prevent deterioration of exhibits in art museums and other exhibit forums

As a Base Unit

The RTR-500 can be registered as a Base Unit so that it can download recorded data from Remote Units via wireless communication and then by connecting it to a PC with a USB cable, the data can be easily downloaded to your computer. Easy USB connection means this type of Base Unit is perfect for on-site use. Downloading recorded data from one Remote Unit at full logging capacity into the Base Unit takes only about 2 minutes.

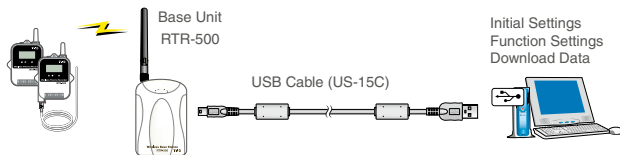

Automatically Download and Send Data

At the set interval, the RTR-500 will communicate via wireless communication with the target Remote Unit(s) and collect recorded data or current readings and send the received data via FTP or e-mail to a set location.

Send Warning Report E-Mails

If and when a measurement exceeds an Upper or Lower Limit or if an abnormality occurs in a Remote Unit the RTR-500 will go into "Warning" mode whereby a warning report will be issued via e-mail to up to four specified e-mail addresses.

Simultaneous Management of Multiple Remote Units

Up to 20 Groups can be registered to an RTR-500 Base Unit. Up to 32 Remote Units can be registered to each Group. With just one RTR-500 it is possible to simultaneously manage up to 640 Remote Units.

Download Data by Manual Operation

Besides Auto-Downloading, it is also possible to download recorded data by carrying out a few simple manual operations. This enables the User to download recorded data from Remote Units whenever necessary. Compared with our previous models, the RTR-500 series provides vastly improved communication time. At a recording interval of ten minutes, you can download one day of data in only five seconds. To download one Remote Unit at full logging capacity will take about two minutes for an RTR-501/502/503 unit and about four minutes for an RTR-574.

Monitor Current Readings on Computer Display

It is possible to monitor and view current readings for groups of Remote Units registered to a RTR-500 Base Unit.

Monitoring Graph Window

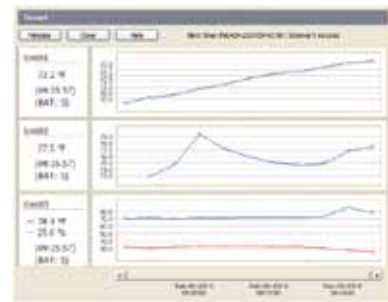

As a Repeater

If you ever wish to expand the wireless communication range the RTR-500 can also be used as a Repeater. When using as a Repeater, it is necessary to use two AA alkaline batteries or purchase the optional AC adaptor (AD-0638 / AD-0638-C) as a power source. When the Repeater is used about five minutes a day, battery life expectancy is about six months. The wireless communication range, if unobstructed and direct, is about 150 meters (500ft).

Note: * When downloading recorded data from a Remote at full logging capacity, it is necessary to add 2 minutes for every Repeater in the route. If from an RTR-501/502/503 it will take an extra 2 minutes; for RTR-574 it will take an extra 4 minutes for each Repeater.

* The package does not include batteries or AC Adaptor. Battery life varies depending upon the battery performance, the communication environment, settings and the frequency of communication.

"T&D WebStorage Service" an online service provided by T&D Corporation

Wouldn't it great if it were possible to share recorded data via the Internet; making it possible to process and manage the data from distant places or allow a number of people in different places to view the same data simultaneously? T&D WebStorage Service makes that dream a reality!

RTR-500GSM, RTR-500 and RTR-500W are all compatible with our revolutionary WebStorage Service. By having your data sent to our WebStorage Service it can then be accessed via an Internet browser from anywhere, anytime, and by any number of people.

<http://www.webstorage-service.com/services/>



By sending measurement records for items in transit to our WebStorage Service all concerned parties can keep track of important data in an easy-to-read graph.

Collect and Check Data on the Spot

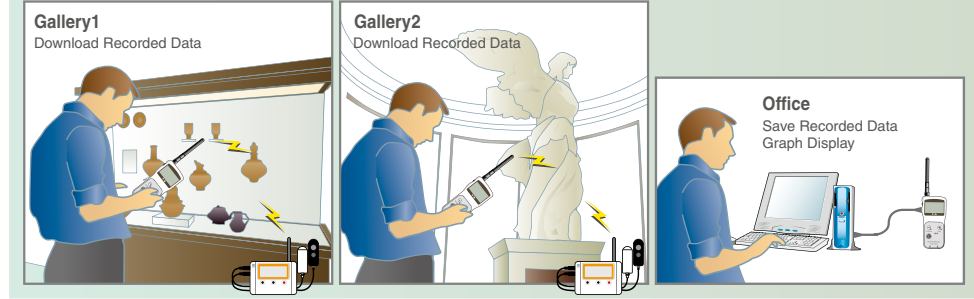

Application Examples

- * For downloading recorded data and monitoring current readings for moving or rotating Remote Units on production lines
- * For downloading recorded data and monitoring current readings for Remote Units in cargo compartments using a Base Unit in the truck cabin
- * For gathering recorded data via wireless communication from long distance or in places where handling of data loggers is difficult or impossible
- * For gathering recorded data about conditions of fine art and important documents in exhibition halls and storage rooms

Ready for Use Without Troublesome Preparation

The RTR-500DC is a user-friendly wireless communication Data Collector designed for hand-held portability. The RTR-500DC does not need troublesome preparation such as creating a network environment or carrying out wiring. All you need is a PC and accessories to use an RTR-500DC.

Easy One-Hand Operation

The handy Operation Dial makes the operation of the RTR-500DC simple; moving the dial up and down displays the various menu selections which can be easily selected by pressing in on the dial. Easy-to-read LCD and simple menu structure enables a quick intuitive operation on site.

On-site Graph Display

The data collected to the RTR-500DC can be immediately viewed in graph form on the spot without the need for a computer. A graph is displayed for each channel of data. It is possible to view, for example, four channels of data measured and recorded by the RTR-574 by pressing the Operation Dial to switch the channel for viewing.

Press and hold the Operation Dial to change the channel on display

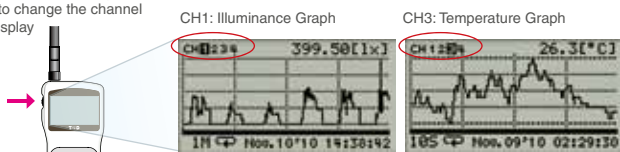

A simple yet functional graph of the RTR-500DC enables you to check the judgement result whether the set Upper/Lower Limit has been exceeded or not, check the highest and lowest readings, as well as zoom in and out.

Monitor for Warning and Current Readings

Using the monitoring function, the RTR-500DC carries out wireless communication at a set interval with the registered Data Loggers (Remote Units) to monitor Current Readings and Remote Unit Status. The RTR-500DC also monitors for warnings in Data Loggers for which the Upper / Lower Limit settings have been made via the supplied software.



Manage Remote Units in Groups with One RTR-500DC Unit

An RTR-500DC can manage a large number of Remote Units. When registering multiple Remote Units, they can be divided into Groups by location or measurement item, each of which can then be assigned a communication frequency channel. The maximum number of Groups which can be registered in one RTR-500DC Unit is 7 (seven). Within each group the maximum number of Remote Units which can be registered is 32 (If using RTR-574 the max is 16).

Operate Same Remote Units via Multiple RTR-500DC Units

Multiple RTR-500DC Units can be used to communicate with one Remote Unit. It is possible, for example, to use one RTR-500DC Unit to monitor the Current Readings and another to collect data, or to have a number of workers carry one each. It is easy to prepare the number of RTR-500DC necessary for the job. After having registered a Remote Unit its registration info can then be sent to multiple RTR-500DC (Base Units), either by using the software "RTR-500DC for Windows" and copying the Base Unit registration info into a multiple number of Base Units, or by using the "Visitor Entry" function by having the Base Unit read the Remote Unit info directly without using the software.

Ex: For monitoring warnings and downloading recorded data from a Remote Unit registered as a "Visitor" in the cargo compartment of a truck.

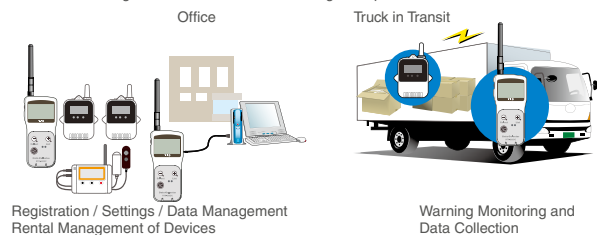

Note: The "Visitor Entry" function enables any RTR-500DC unit to accept "visitors" or Remote Units which have been previously registered to another RTR-500DC; allowing any RTR-500DC unit to directly communicate with the accepted Remote Unit without the need for registration via a PC. Note that this function can only be used with Remote Units that have already been registered.

Various Power Supplies and Energy Saving Function

Power is provided by two AAA alkaline batteries. It is also possible to supply power to the RTR-500DC Unit from AAA Ni-MH batteries, USB bus power, or AC adaptor (optional). The energy saving function will automatically turn off the Unit to save battery power if the Unit is not used for about three minutes.

LCD Backlight Display for Reading in the Dark

The RTR-500DC has a LCD backlight display to help you read data even in the dark. If the Unit is not used for more than five seconds, the LCD backlight will automatically turn OFF to save battery power. Once operation is re-started, it will automatically turn back ON. When the Unit is connected to an AC adaptor, the backlight remains ON.

Software Included with Base Unit

Free of Charge! Software Updates and Info available on our WebSite!



RTR-500GSM for Windows

This software is made up of three applications:
RTR-500GSM Settings Utility
Temperature / Humidity Graph
Adjustment Tools



RTR-500 for Windows

This software is made up of five applications:
RTR-500 Settings Utility
RTR-500 for Windows
Temperature / Humidity Graph
Multi-Scale Graph
Adjustment Tools

EU Version now comes in English, Spanish, French, Italian and German!



RTR-500W for Windows

This software is made up of five applications:
RTR-500W Settings Utility
Temperature / Humidity Graph
Multi-Scale Graph
Data Download Tool
Adjustment Tools



RTR-500DC for Windows

This software is made up of six applications:
RTR-500DC Settings Utility
RTR-500 DC Manager
Temperature / Humidity Graph
Multi-Scale Graph
Data Download Tool
Adjustment Tools

■ "Settings Utility" Program makes Settings a Snap!

The Settings Utility application is used to take care of all Base Unit settings and registration of Remote Units and Repeaters. After having registered and placed the Remote Units and Repeaters in the field, it is possible to run communication tests to check signal strength between the various units to ensure stable communication.

■ Easy-to-Understand Operation Guide

The Operation Guide that is part of the software uses easy to understand terms to help lead you through all the necessary steps and setting procedures. If during setup you get confused or have trouble, just simply open the Operation Guide in the same on-screen window and make settings while consulting the Guide.

■ Difficult Cellular Phone Network Settings made Easy

When using the RTR-500GSM, we have included an "Initial Settings Wizard" which guides you through what otherwise would be difficult process of setting up the unit for GSM network communication, just put in the SIM Card and turn on the Wizard.

■ Intuitive User-Friendly Graph Tools (Temperature / Humidity Graph and Multi-Scale Graph)

With either program you can view up to eight channels of data in one graph. The Graph programs intuitive operation allows the User to easily hide or view channels, zoom in and out on data, switch back and forth from °C to °F, and view data in table form.

Temperature / Humidity Graph
(Recorded data from RTR-501/502/503)

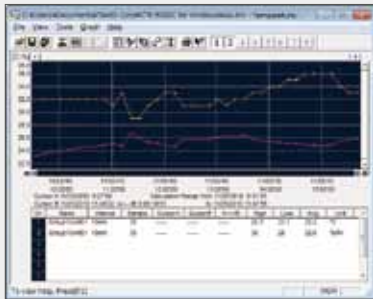

Multi-scale Graph
(Recorded data from RTR-574)

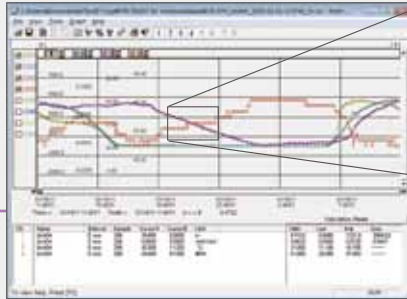

Enlarged View

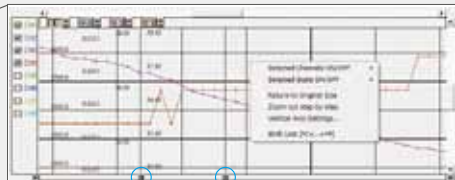

Data List Display

Date/Time	tr	mW/cm ²	°C	°F	ch.1	ch.2	ch.3	ch.4	ch.5	ch.6	ch.7
01/10/2011 13:37:52	4321.000	0.070	19.100	34.380							
01/10/2011 13:38:52	4327.000	0.080	19.500	34.900							
01/10/2011 13:41:52	4716.000	0.081	20.800	33.000							
01/10/2011 13:46:52	4408.000	0.091	20.300	34.000							
01/10/2011 13:55:52	4105.000	0.100	21.300	34.000							
01/10/2011 13:58:52	4134.000	0.092	20.800	33.000							
01/10/2011 14:01:52	4009.000	0.091	20.800	33.000							

View in Table Form

Graph data can be easily viewed as a data list. The highest and lowest values are shown in easily distinguishable colors.

From Graph Editing to Data Analysis

It is possible to hide, re-order and delete channels, edit recording start times, and make changes to colors used for the graph scale lines, data lines and background. Also move the A and B cursor at the bottom of the graph to view data readings for those points and the calculated difference between the points. By saving graph data as CSV Format Text File data, that data can then be uploaded into common spreadsheet software for data analysis.

trz./ trx. / iur Type Data

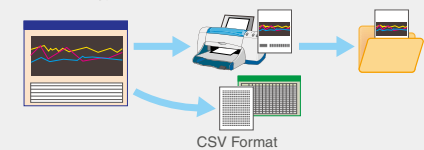

■ Remote Unit Adjustment Settings

When using multiple measuring devices, this function allows the user to correct for inaccuracies found in measured values when compared to a standard measurement (the value measured by the standard device). Measurements can be adjusted and recorded based on a standard measurement. The RTR-500 Series Software allows for adjustment settings to be made to Remote Unit measurements by simply selecting the adjustment method from either "1 Point Adjustment" or "2 Point Adjustment" and entering the values for "Before Adjustment" and "After Adjustment".

Wireless Data Logging System RTR-500 Series Optional Sensors

Temperature Sensors for RTR-502 / 502L

Possible Temperature Measurement Range: - 60 to 155°C / Sensor Temperature Resistance: -70 to 180°C

Temp Measurement Accuracy: Average $\pm 0.3^{\circ}\text{C}$ (-20 to 80°C) Average $\pm 0.5^{\circ}\text{C}$ (-40 to -20°C / 80 to 110°C) Average $\pm 1.0^{\circ}\text{C}$ (-60 to -40°C / 110 to 155°C)

① Thermistor ② Stainless pipe (SUS316) ③ Fluoropolymer Compaction Tube ④ Fluoropolymer Coated Electrical Wire ⑤ Fluoropolymer Coated Mold

Fluoropolymer Coated Sensor

[Unit : mm]

TR-5101

Cable Length: 45mm
Thermal Time Constant:
Approx. 30 Sec. (in air)
Approx. 4 Sec. (in agitated water)

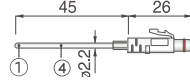

TR-5106

Cable Length: 0.6m
Thermal Time Constant:
Approx. 30 Sec. (in air)
Approx. 4 Sec. (in agitated water)

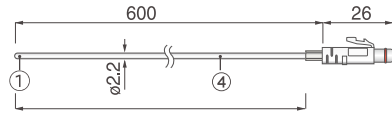

* Water Resistance: The fluoropolymer-coated section is waterproof. Other sections are immersion proof

Water Immersible Sensor

TR-5530

Cable Length: 3.0m
Thermal Time Constant:
Approx. 120 Sec. (in air)
Approx. 6 Sec. (in agitated water)

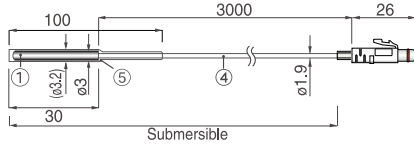

Stainless Protection Sensor

[Unit : mm]

TR-5220

Cable Length: 2.0m
Thermal Time Constant:
Approx. 36 Sec. (in air)
Approx. 7 Sec. (in agitated water)

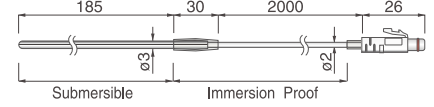

TR-5320

Cable Length: 2.0m
Thermal Time Constant:
Approx. 12 Sec. (in air)
Approx. 2 Sec. (in agitated water)

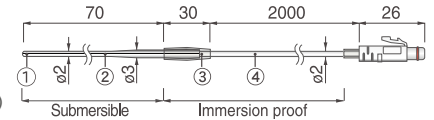

TR-5420

Cable Length: 2.0m
Thermal Time Constant:
Approx. 12 Sec. (in air)
Approx. 2 Sec. (in agitated water)

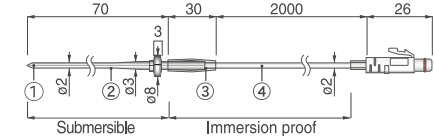

Temperature Sensor Extension Cable for RTR-502 / 502L

TR-2C30 (Only use for Temperature Sensors)

Cable Length: 3.0m
Splash Resistant

Materials:
① Vinyl Coated Electrical Wire

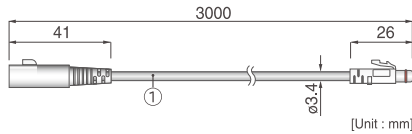

Note: *An error of about $+0.3^{\circ}\text{C}$ occurs at normal temperature while an error of about $+0.5^{\circ}\text{C}$ will occur at around -50°C .

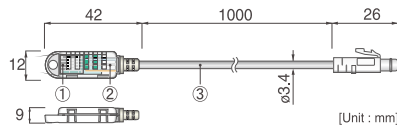

Temperature / Humidity Sensor for RTR-503 / 503L

TR-3310

① Temperature/Humidity Sensor
② Polypropylene Resin
③ Vinyl Coated Electrical Wire

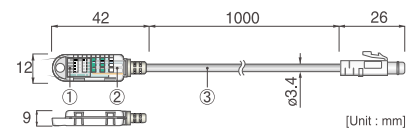

Cable Length: 1.0m

Possible Temperature Measurement Range: 0 to 55°C

Possible Humidity Measurement Range: 10 to 95%RH

Sensor Temperature Resistance: -10 to 60°C

Sensor Response Time: About 7 min. (90% response)

Measurement Accuracy:

Temperature Avg. $\pm 0.3^{\circ}\text{C}$ (At 25°C, 50%RH)

Humidity Avg. $\pm 5\% \text{RH}$ (At 25°C, 50%RH)

Service Life: 1 year (under normal operational conditions)

Operational Conditions: Do not expose to condensation, dampness, from corrosive gasses or organic solvents.

Sensors for RTR-574

Illuminance UV Sensor

ISA-3151

① Polycarbonate
② Glass
③ Vinyl chloride-shielded wire

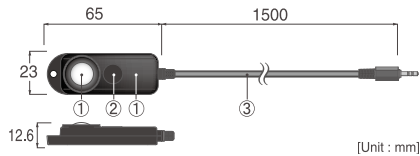

Measurement Items	Illuminance	UV Intensity
Measurement Range	0 to 130,000lx	0 to 30mW/cm2
Measurement Resolution	Minimum: 0.01 lx	Minimum: 0.001 mW/cm2
Measuring Accuracy (*1)	10 to 100,000 lx: $\pm 5\%$ (at 25°C and 50%RH)	0.1 to 30 mW/cm2 $\pm 5\%$ (at 25°C and 50%RH)
Relative Spectral Response	Approximated to the CIE standard response function V (λ).	260 to 400 nm
Cosine Correction (cos θ)	Within $\pm 1.5\%$ at 10° Within $\pm 3\%$ at 30° Within $\pm 10\%$ at 60° Within $\pm 30\%$ at 80°	-
Operating Environment	Temperature: -10 to 60°C Humidity: 90%RH or less (no condensation)	-
Conditions for Use	Do not expose to condensation, dampness, corrosive gases or organic solvents	
Cable Length	1.5m	

(*1) Compared to the value measured by the T&D standard sensor for calibration under our calibration light source.

Temperature / Humidity Sensor

THA-3151

① Polycarbonate
② Vinyl chloride-shielded wire

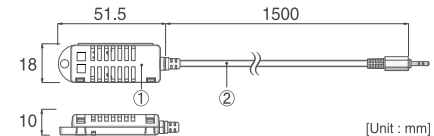

Measurement Items	Temperature	Humidity
Measurement Range	0 to 55 °C	10 to 95%RH
Measurement Resolution	0.1 °C	1%RH
Measuring Accuracy	Avg. $\pm 0.3^{\circ}\text{C}$	$\pm 5\%$ (at 25°C and 50%RH)
Sensor Response Time	About 7 min. (90%)	
Humidity Hysteresis	-	$\pm 1\% \text{RH}$ (30 to 90%RH)
Operating Environment	Temperature: 0 to 55 °C Humidity: 90%RH or less (no condensation)	
Conditions for Use	Do not expose to condensation, dampness, corrosive gases or organic solvents	
Cable Length	1.5m	

Sensor Extension Cable

TR-1C30

Cable Length: 3 m
Temperature Durability:
-25 to 60 °C
Material: Vinyl chloride-shielded wire

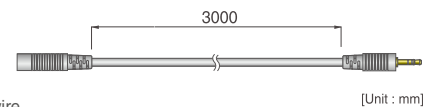

Up to 3 extension cables can be connected to one sensor (Temperature/Humidity Sensor THA-3151 and Illuminance UV Sensor ISA-3151).

Wireless Data Logging System RTR-500 Series Options

Options for RTR-500GSM

AC Adaptor

AD-0605

Cable Length: 1.85m
Input: AC100V (90-132V)
Output: DC 5V 2A
Frequency: 50 / 60Hz
Plug Type: A

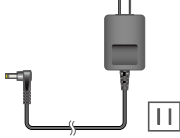

AD-0607

Cable Length: 1.85m
Input: AC 100-240V(93-264V)
Output: DC 5V 2A
Frequency: 50 / 60Hz
Plug Type: C

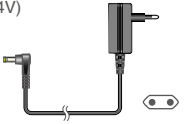

Wall Attachment

TR-5GK1

Contents:
Lock Screw x 2
Double-sided Adhesive tape x 1
Dimensions:
W73 x H72 x D43 mm
Screw Holes: 2 - ϕ 4.2
① Aluminum ② Rubber

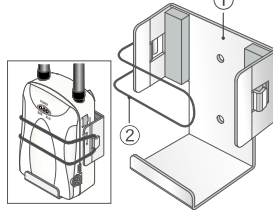

External Power Cable

BC-0201

Power Source Conditions:
Voltage: DC 8-34V
Current: MAX 2A

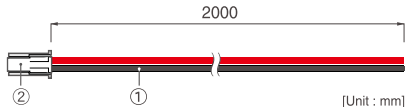

① Cable: AWG#20, Red: Plus (+), Black: Minus (-)
② Connector: Housing: XAP-02V-1, Contact: SXA-01T-P0.6 (J.S.T. Mfg. Co., Ltd.)

Options for RTR-500W / RTR-500 / RTR-500DC

AC Adaptor

AD-0638

Cable Length: 1.8m
Input: AC100-240V
Output: DC6V 500mA
Frequency: 50 / 60Hz
Plug Type: A

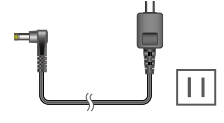

AD-0638-C

Cable length: 1.8m
Input: AC100-240V
Output: DC6V 500mA
Frequency: 50/60Hz
Plug Figure: C (with Plug Adaptor)

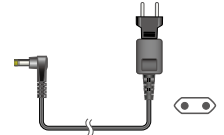

Options for RTR-500W

Wall Attachment

TR-5WK1

Contents:
Screw for fastening to wall x 2
Double-sided Tape x 1
Screw for fastening Unit x 1
Dimensions:
W106 x H86 x D17.8mm
Screw holes: 2 - ϕ 3.2

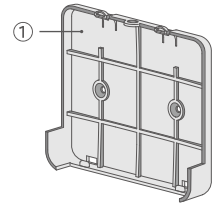
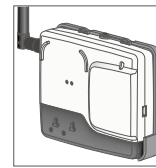

① PC Resin

Options for Data Loggers

External Power Adaptor Kit

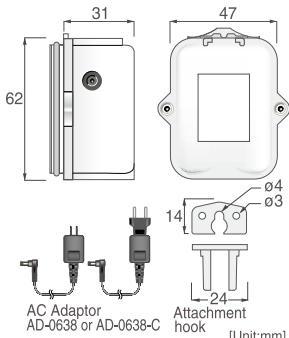

RTR-500A1

Voltage Input: DC6V
Back-up Power:
Ni-MH Battery (In case of power loss)
Back-up Time: 4 days (*1)
Charging Method: Trickle Charge
Operating Temperature: 0 to 60°C
Waterproof Capability: None
Weight: about 37g (without AC Adaptor)
Kit Contents:
External Power Adaptor x 1
AC Adaptor (AD-0638 or AD-0638-C) x 1
Attachment hook x 1
Rubber Packing (small) x 1 (for AC Adaptor jack)
and Maintenance Set (TR-00P1)

Install by taking off the back cover and removing the battery.

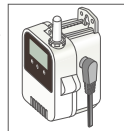

(*1) Battery Life varies depending on measuring environment, recording interval, transmission frequency, and ambient temperature. The battery life estimated here is calculated using a new battery under normal operating conditions and in no way should be understood as a guarantee of battery life.

Large Capacity Battery Kit

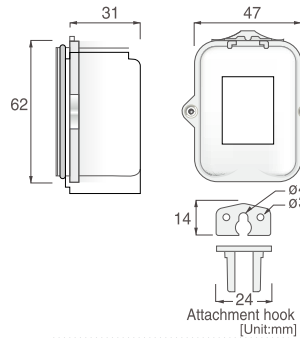

RTR-500B1

Power: Lithium Battery x 1 (LS26500) (*1)
Battery Life: about 4 years (*2)
Waterproof Capability: Splash proof
Operating Temperature: -40 to 80°C (*3)
Weight: about 75g (including Lithium Battery)
Kit Contents:
Large Capacity Battery Adaptor x 1
Attachment hook x 1
and Maintenance Set (TR-00P1)

Install by taking off the back cover and removing the battery.

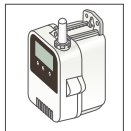

(*1) When using RTR-500B1 it is necessary to purchase Lithium Battery (LS26500). For details, contact your local authorized distributor.

(*2) Battery Life varies depending on measuring environment, recording interval, transmission frequency, and ambient temperature. The battery life estimated here is calculated using a new battery under normal operating conditions and in no way should be understood as a guarantee of battery life.

(*3) Operating temperature depends on the specifications for the data logger being used.

Wall Attachments

TR-05K3 for RTR-501/502/503

Material: Polycarbonate
Contents:
Lock Screw x 2
Double-sided Adhesive tape x 1
Dimensions:
W66.6 x H70 x D24.7mm
Screw Holes: 2 - ϕ 4.2

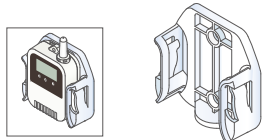

TR-05K3L for L type

Material: Polycarbonate
Contents:
Lock Screw x 2
Double-sided Adhesive tape x 1
Dimensions:
W66.6 x H70 x D51.7 mm
Screw Holes: 2 - ϕ 4.2

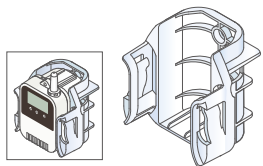

Note: Cracks may develop if exposed to strong impact at temperatures of -30°C or less.

TR-07K2 for RTR-574

Material: Polycarbonate
Contents:
Lock Screw x 2
Double-sided Adhesive tape x 1
Screw Holes: 2 - ϕ 4.2

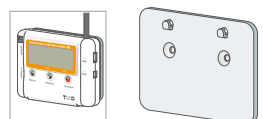

Maintenance Set for RTR-501 / 502 / 503

TR-00P1

Contents:
Rubber Packing x 1
Silica Gel x 1
Double-sided Adhesive Tape x 1
Lock Screw x 2

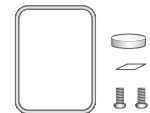

Battery Set for RTR-501 / 502 / 503

TR-11P2

Contents:
Lithium battery SAFT(LS14250) x 1
Tube x 1
Maintenance Set (TR-00P1) x 1

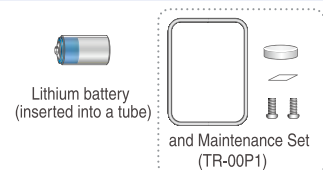

Wireless Data Logging System RTR-500 Series

Product Specifications

Mobile Base Station RTR-500GSM

UNIT	
Compatible Devices	Remote Units: RTR-501/502/503, RTR-501L/502L/503L Repeater: RTR-500
Features and Functions	1. Auto-downloading of Recorded Data (E-mail or FTP), 2. Automatic Sending of Current Readings (E-mail or FTP), 3. Warning Monitoring (SMS, E-mail or Contacts) 4. SMS Remote Control - Stop and Start Functions 1, 2, 3, above - Request Immediate Download of Data to Set Address
Types of Warning Monitoring	Remote Unit Measurement Warnings, Remote Unit Wireless Communication Error Warnings, Remote Unit Battery Level Warnings, Remote Unit Sensor Abnormality Warnings, Base Unit External Power Loss Warnings (only when batteries are installed), Base Unit Battery Level Warnings / Base Unit External Contact Input Warnings
Power	AA Alkaline Batteries x 4 External Power (DC8 - 34V) AC Adaptor (AD-0605 / AD-0607)
Current Consumption	At most 2A (5V, with GSM in operation)
Communication Interfaces	USB (with PC) Optical Communication (with Remote Unit)
LED Display	POWER: Green / ERR: Orange / ALM: Red
Battery Life	10 days* of continued use if monitoring is carried out every 10 minutes (when not using GPS).
Dimensions	H 96 mm x W 65 mm x D 39 mm (Excluding protrusions) Antenna Length : 109mm
Weight	About. 220 g (including batteries)
Operating Environment	Temperature: 10 to 55 °C (-10 to 55 °C when external power connected) Humidity: 20 to 80%RH (No condensation)
Other	Not waterproof, moistureproof, or dustproof. The SIM card must adhere to the following conditions: 1. Compatible with GSM. 2. Able to use SMS (Short Message Service) and GPRS (General Packet Radio Service). 3. The card has been activated.

* Battery life varies depending upon the frequency of communication, the measuring environment, and the quality of the batteries being used.

Short Range Radio Communication

RF Power	FCC model 7mW CE model 5mW
Radio Standard Specifications	FCC Part15 Section247 / IC RSS-210 (Frequency Range: 902 to 928MHz) ETSI EN 300 220 (Frequency Range: 869.7 to 870MHz)
Transmission Range	About 150meters (500ft) if direct and unobstructed.
Communication Time	When downloading 1 Remote Unit at full logging capacity: About 2 min. * The same amount of time will be necessary for each added Repeater.

Cellular Phone Communication

Band	GSM850/GSM1900(PTCRB Certified) GPRS(General Packet Radio Service) GSM900/GSM1800 GPRS(General Packet Radio Service)
Data Transfer Protocol	FTP (PASV mode also supported) SMTP (SMTP-AUTH, POP-before SMTP) * SMTP-AUTH supports LOGIN only
Warning Monitoring Function	SMS / SMTP (SMTP-AUTH, POP-before SMTP) * SMTP-AUTH supports LOGIN only

Contacts (Warning Output / Input)

Output Terminal Open Drain Output	Voltage when OFF: DC less than 30V Current when ON: less than 0.1A Resistance when ON: 15Ω
Input Terminal	Internal Pull-up: 3V 100kΩ Maximum Input Voltage: 30V

GPS Communication (Option)

GPS Interface	Connector: Mini DIN 6 Pin Female Communication Standard: ANSI / EIA/TIA-232-E Geographic Coordinate System: WSG84 Power Supply: 5V MAX 100mA
Other	Attach geographical positioning info to Current Readings

Wireless Base Station RTR-500

UNIT	As a Base Unit	As a Repeater
Compatible Devices	Remote Units: RTR-501/502/503, RTR-501L/502L/503L RTR-574 Repeater: RTR-500	Base Unit: RTR-500GSM RTR-500 RTR-500NW/500AW RTR-500DC
Features and Functions	When connected to a PC with "RTR-500 for Windows" running: 1. Auto-downloading of Recorded Data (E-mail or FTP), 2. Automatic Sending of Current Readings (E-mail or FTP), 3. Warning Monitoring (E-mail)	-
Types of Warning Monitoring	Remote Unit Measurement Warnings, Cumulative Illuminance/Amount of UV Light Warnings (RTR-574), Remote Unit Wireless Communication Error Warnings, Remote Unit Battery Level Warnings, Remote Unit Sensor Abnormality Warnings	-
Power	USB bus power	AA alkaline batteries x 2 AC adaptor (AD-0638 / AD-0638-C)
Operating Voltage	2.5V to 7.0V	
Current Consumption	Approx. 50mA (Wireless Communication)	
Communication Interfaces	USB (with PC) Optical Communication (with Compatible Remote Units other than RTR-574)	
LED Display	Blinking: During Wireless Communication or PC Communication Lamp ON: Connected PC via USB	
Battery Life	-	About 6 months*
Dimensions	H 96mm x W 65mm x D 25mm (excluding protrusions) Antenna Length : 109mm	
Weight	Approx. 71g (Batteries not included)	
Operating Environment	Temperature: -10 to 60 °C (-30 to 60 °C when external power connected) Humidity: 20 to 80%RH (No condensation)	
Other	Not waterproof, moistureproof, or dustproof	

* When used for wireless communication five minutes a day. Battery life varies depending upon the measuring environment, the communication frequency, and the quality of the battery being used.

Short Range Radio Communication

RF Power	FCC model 7mW CE model 5mW
Radio Standard Specifications	FCC Part15 Section247 / IC RSS-210 (Frequency Range: 902 to 928MHz) ETSI EN 300 220 (Frequency Range: 869.7 to 870MHz)
Transmission Range	About 150meters (500ft) if direct and unobstructed.
Communication Time	When downloading one Remote Unit at full logging capacity: About 2 min. (Remote Units excluding RTR-574) About 4 min. (RTR-574) *The same amount of time will be necessary for each added Repeater.

Network Communication

Data Transfer Protocol		
When connected to a PC as a Base Unit with "RTR-500 for Windows" running:		
Auto-Downloading of Recorded Data / Auto-Sending of Current Readings	FTP (PASV mode also supported) SMTP (SMTP-AUTH, POP-before SMTP) * SMTP-AUTH supports PLAIN, LOGIN and MD5	
Warning Monitoring Function	SMTP (SMTP-AUTH, POP-before SMTP) * SMTP-AUTH supports PLAIN, LOGIN and MD5	

Wireless Data Logging System RTR-500 Series Product Specifications

Network Base Station RTR-500W

UNIT	
Compatible Devices	Remote Units: RTR-501/502/503, RTR-501L/502L/503L, RTR-574 Repeater: RTR-500
Features and Functions	1. Auto-downloading of Recorded Data (E-mail /FTP) 2. Automatic Sending of Current Readings (E-mail / FTP) 3. Warning Monitoring (E-mail / Contacts)
Types of Warning Monitoring	Remote Unit Measurement Warnings, Cumulative Illuminance/Amount of UV Light Warnings (RTR-574), Remote Unit Wireless Communication Error Warnings, Remote Unit Battery Level Warnings, Remote Unit Sensor Error Warnings, and Base Unit External Contact Input Warnings
Power	AC Adaptor (AD-0638 / AD-0638-C)
Current Consumption	RTR-500NW: Approx. 300mA RTR-500AW: Approx. 400mA
Communication Interfaces	USB (with PC) Optical Communication (with Compatible Remote Units other than RTR-574) Wired LAN (RTR-500NW) / Wireless LAN (RTR-500AW)
LED Display	POWER, ACTIVE, DIAG, and ALARM
Dimensions	H83mm x W102mm x D28mm (excluding protrusions) Antenna Length: 87.3mm
Weight	RTR-500NW: About 130g RTR-500AW: About 120g (including antenna for each)
Operating Environment	Temperature: -10 to 60°C Humidity: 20 to 80%RH (no condensation)
Other	Not waterproof, moistureproof, or dustproof

Short Range Radio Communication

RF Power	FCC model 7mW / CE model 5mW
Radio Standard Specifications	FCC Part15 Section247 / IC RSS-210 (Frequency Range: 902 to 928MHz) ETSI EN 300 220(Frequency Range: 869.7 to 870MHz)
Communication Range	About 150meters (500ft) if direct and unobstructed.
Communication Time	When downloading one Remote Unit at full logging capacity: About 2 min. (Remote Units excluding RTR-574) About 4 min. (RTR-574) *The same amount of time will be necessary for each added Repeater.

LAN Communication

Wired LAN (RTR-500NW)	RJ45 Connector 100Base-TX / 10Base-T AutoMDI / MDI-X
Wireless LAN (RTR-500AW)	Internal wireless LAN antenna IEEE 802.11b/g WEP, WPA/WPA2 (PSK)
Data Transfer Protocol	Auto-Downloading of Recorded Data / Auto-Sending of Current Readings Warning Monitoring Function
	FTP (PASV mode also supported) SMTP (SMTP-AUTH, POP-before SMTP) *SMTP-AUTH supports LOGIN only SMTP (SMTP-AUTH, POP-before SMTP) *SMTP-AUTH supports LOGIN only

Contacts (Warning Output / Input)

Output Terminal	Voltage when OFF: AC/DC 50V or less Current when ON: 0.1A or less Resistance when ON: 35Ω
Input Terminal	Internal Pull-up: 3V 100kΩ Maximum Input Voltage: 30V

Wireless Data Collector RTR-500DC

UNIT	
Compatible Devices	Remote Unit: RTR-501 / 502 / 503, RTR-501L / 502L / 503L, RTR-574 Repeater: RTR-500
Logging Capacity	When downloading units at full logging capacity: 15 units of RTR-501 / 502 15 units of RTR-503 7 units of RTR-574 When downloading units at non-full storage capacity, it can store and manage up to 250 downloading sessions. *Varies depending upon the device type, number of channels, type of recorded data.
Internal Clock Accuracy	At ±30 seconds/month and 25°C
LCD Display	FSTN 1.9 inch, 128 x 64 dot, semi-transmissive, monochrome, amber colored LED backlight
Functions: Wireless Communication	Downloading and Saving Recorded Data, Monitoring Current Readings and Remote Unit Status (Warning Monitoring), Starting and Stopping Remote Unit Recording, Checking Signal Strength for Communication with Remote Unit
Functions: Non-Wireless Communication	Downloading and Saving Recorded Data Starting and Stopping Remote Unit Recording
Functions: RTR-500DC Operations	Changing Unit of Temperature, LCD Backlight, LCD Contrast, Checking Memory, Button Sound, Checking Battery Power, Auto Power Off Function (if the Unit is not used for three minutes)
Display Functions	Graph (Highest / Lowest Measurement, Upper / Lower Limit Settings) Data Details (Downloading Date/Time, Recording Start Date/Time, Recording Stop Date/Time, Last Recording Date/Time)
Types of Warning Monitoring	Upper Limit / Lower Limit Exceeded Upper Limit / Lower Limit Exceeded for Cumulative Illuminance and Cumulative Amount of UV Light (RTR-574)
Power	AAA Alkaline Battery x 2 * AAA Ni-MH batteries, AC adaptor (option AD-0638 / AD-0638-C), or USB bus power may also be used.
Battery Life	Expected battery life for 2 AAA alkaline batteries: Monitoring: 96 hours of continued use For communication without Repeater(s) at 60 seconds interval Checking Signal Strength: 32 hours of continued use Downloading Data: 730 consecutive sessions Via wireless communication (When downloading RTR-501 at full logging capacity / without Repeater(s) / LCD backlight Off) * Battery life varies depending upon the type of battery, the measuring environment, the frequency of communication, and the ambient temperature in which it is used.
Data Backup	About 1 month (Saved data will be erased if all battery power is lost.)
Communication Interfaces:	With PC: USB Communication: 38,400bps With Remote Unit: Wireless Communication Optical Communication: 2,400bps (Remote Units excluding RTR-574) Cable Communication: 19,200bps (RTR-574)
Communication Time (excluding Wireless Communication)	About 1 month (Saved data will be erased if all battery power is lost.) When downloading one Remote Unit at full logging capacity: - From RTR-500DC to PC USB Communication: 12 sec. (1Ch) / 24 seconds (4Ch) - From Remote Unit to RTR-500DC Optical Communication: about 170 seconds (Remote Units excluding RTR-574) Cable Communication: about 45 seconds (RTR-574)
Dimensions	H125mm x W58mm x D26.3mm (excluding protrusions) Antenna Length: 109mm
Weight	About 127g (including 2 AAA batteries)
Operating Environment	Temperature: 0 to 50°C / Humidity: 90%RH or less (no condensation)
Others	Not waterproof, moisture proof, or dust proof

Short Range Radio Communication

RF Power	FCC model 7mW / CE model 5mW
Radio Standard Specifications	FCC Part15 Section247 / IC RSS-210 (Frequency Range: 902 to 928MHz) ETSI EN 300 220(Frequency Range: 869.7 to 870MHz)
Communication Range	About 150meters (500ft) if direct and unobstructed.
Communication Time	When downloading one Remote Unit at full storage capacity: About 120 sec. (Remote Units excluding RTR-574) About 240 sec. (RTR-574) *The same amount of time will be necessary for each added Repeater.

Software Operating Environment

For installation, it is necessary to have Administrator (Computer Administrator) rights.

Software Names and Compatible Devices	RTR-500GSM for Windows (RTR-500GSM) RTR-500W for Windows (RTR-500NW, RTR-500AW) RTR-500 for Windows (RTR-500) RTR-500DC for Windows (RTR-500DC)
PC / CPU	A Stable Windows Operating Environment
Memory	A Stable Windows Operating Environment
Hard Disk	More than 30 MB of free space (Data will need more space)
Monitor	SVGA (800 x 600) more than 256 colors

Compatible OS (US)	Microsoft® Windows® 7 32/64bit English Microsoft® Windows Vista® 32bit English Microsoft Windows® XP 32bit (SP2 or above) English
Compatible OS (EU)	Microsoft® Windows® 7 32/64bit English, Spanish, French, German, Italian Microsoft® Windows Vista® 32bit English, Spanish, French, German, Italian Microsoft Windows® XP 32bit (SP2 or above) English, Spanish, French, German, Italian

Wireless Data Logging System RTR-500 Series Product Specifications

Wireless Data Loggers

UNIT	RTR-501 / RTR-501L	RTR-502 / RTR-502L	RTR-503 / RTR-503L	
Measurement Items	Temperature	Temperature	Temperature	Humidity
Number of Channels	1 Ch	1 Ch	1 Ch	1 Ch
Unit of Measurement	°C, °F	°C, °F	°C, °F	%
Measurement Range	- 40 to 80°C	- 60 to 155°C	0 to 55°C	10 to 95%RH
Sensor	Internal Temp. Sensor	External Temp. Sensor (TR-5106)	External Temp. and Humidity Sensor (TR-3310)	
Thermal Time Constant	15 minutes L type: 25 minutes	Approx. 15 Sec. (in air) Approx. 2 Sec. (in agitated water)	-	
Sensor Response Time	-	-	About 7 min. (90% response)	
Measurement Accuracy	Avg. +/- 0.5°C	Avg. +/- 0.3°C (-20 to 80°C) Avg. +/- 0.5°C (- 40 to -20°C / 80 to 110°C) Avg. +/- 1.0 °C (- 60 to -40°C / 110 to 155°C)	Avg. +/- 0.3°C (at 25°C and 50%RH)	+/-5%RH (at 25°C and 50%RH)
Measurement Display Resolution	0.1°C	0.1°C	0.1°C	1%RH
Recording Intervals	Select from 15 choices: 1, 2, 5, 10, 15, 20 and 30 sec. / 1, 2, 5, 10, 15, 20, 30 and 60 min.			
Logging Capacity	16,000 readings	16,000 readings	8,000 data sets (*1)	
Recording Modes (*2)	ENDLESS (Upon reaching logging capacity, the oldest data is overwritten and recording continues) ONETIME (Upon reaching logging capacity, recording will automatically stop)			
LCD Display Items	Current Readings, Recording Status, Battery Life Warning, Messages, Unit of Measurement			
Power	Lithium Battery (LS14250 (SAFT)) x 1 / L type: Large Capacity Battery Adaptor Kit (RTR-500B1) x 1 (*5) External Power Adaptor Kit (RTR-500A1) (sold separately)			
Battery Life (*3)	About 10 months / L type: About 4 years The stated battery life is for when it is used in an environment of 25°C and recorded data is downloaded at a rate of once a day or "Monitoring Current Readings" occurs at a rate of once every 10 minutes.			
Communication Interfaces	Short Range Radio / Optical Communication			
Radio Standard Specifications	FCC Part15 Section247 / IC RSS-210 (Frequency Range: 902 to 928MHz) / ETSI EN 300 220(Frequency Range: 869.7 to 870MHz)			
Wireless Transmission Range	About 150meters (500ft) if unobstructed and direct			
Communication Time	When downloading one Remote Unit at full logging capacity: Wireless communication : about 2 min. (*4) / Optical communication : about 160 sec.			
Water Resistance	Immersion Proof	Splash Proof (*6)		
Dimensions	H62mm x W47mm x D19mm / L type: D46.5mm (with Large Capacity Battery Pack) (excluding protrusions / antenna length 24mm)			
Weight	About 56g (including 1 lithium battery) / L type: about 109g (with Large Capacity Battery Pack)			
Unit Temp. Resistance	Resistance -30 to 80°C (Unit temp resistance and measurement range is -40 to 80°C but wireless communication cannot occur in an environment of less than -30°C)			
Others	In order to download data via wireless communication, it is necessary to purchase a Base Unit: RTR-500GSM, RTR-500, RTR-500AW, RTR-500NW, or RTR-500DC			

UNIT	RTR-574			
Measurement Items	Illuminance	UV Intensity	Temperature	Humidity
Number of Channels	1 Ch	1 Ch	1 Ch	1 Ch
Unit of Measurement	lx, Klx	mW/cm ²	°C, °F	%
Measurement Range	0 to 130,000lx	0 to 30mW/cm ²	0 to 55°C	10 to 95%RH
Measurement Resolution	Minimum: 0.01 lx	Minimum: 0.001 mW/cm ²	0.1°C	1%RH
Measuring Accuracy	10 to 100,000 lx: +/-5% (At 25°C, 50%RH)	0.1 to 30 mW/cm ² : +/-5% (At 25°C, 50%RH) (*7)	Avg. +/-0.3°C	+/-5% (At 25°C, 50%RH)
Display Range of Cumulative Measurement	0 to 90,000,000 lx.h	0 to 62W/cm ² .h	-	-
Unit of Cumulative Measurement	Cumulative Illuminance lx.h, Klx.h, Mlx.h	Cumulative Amount of UV Light mW/cm ² .h, W/cm ² .h	-	-
LCD Refresh Interval	1 second (At a recording Interval of 1 second) / 2 seconds (At a recording interval of 2 seconds or more)			
Recording Intervals	Select from 15 choices: 1, 2, 5, 10, 15, 20 and 30 sec. / 1, 2, 5, 10, 15, 20, 30 and 60 min.			
Logging Capacity (*1)	8,000 data sets			
Recording Modes (*2)	ENDLESS (Overwrite oldest data when capacity is full) / ONETIME (Stop recording when capacity is full)			
LCD Displayed Items (*8)	Recording Status, Amount of Recorded Data, Communication Status, Recording Mode, Battery Life Warning, Unit of Measurement Current Readings (Illuminance / UV Intensity / Temperature / Humidity), Cumulative Measurements (Cumulative Illuminance and Cumulative Amount of UV Light),			
Communication Interfaces	Short Range Radio, USB, RS-232C (Serial) Communication (*9)			
Communication Time	When downloading one Remote Unit at full storage capacity: Wireless Communication = about 4 min. (*4) / USB Communication = about 45 sec.			
Radio Standard Specifications	FCC Part15 Section247 / IC RSS-210 (Frequency Range: 902 to 928MHz) / ETSI EN 300 220(Frequency Range: 869.7 to 870MHz)			
Wireless Transmission Range	About 150 meters (500 ft) if unobstructed and direct			
Power	AA Alkaline Battery (LR6) x 1			
Battery Life (*3)	About 4 months			
Dimensions	H55mm x W78 mm x D18 mm (excluding protrusions) / Antenna Length: 60mm			
Weight	About 66g (including AA Alkaline Battery / excluding sensors)			
Operating Environment	Temperature : -10 to 60°C / Humidity : 90%RH or less (no condensation)			
Others	In order to download data via wireless communication, it is necessary to purchase a Base Unit: RTR-500GSM, RTR-500, RTR-500AW, RTR-500NW, or RTR-500DC Not waterproof, moistureproof, or dustproof.			

(*1) One data set consists of readings for all channels in that type of unit.

(*2) When using RTR-500GSM, RTR-500NW or RTR-500AW as a Base Unit, only "ENDLESS" can be selected. When using an RTR-500 or RTR-500DC as a Base Unit, possible to select from either "ENDLESS" or "ONETIME".

(*3) Battery life varies depending upon the type of battery, the battery performance, the measuring environment, and the frequency of communication.

(*4) The same amount of time will be necessary for each added Repeater.

(*5) When using RTR-500B1 it is necessary to purchase Lithium Battery (LS26500). For details, contact your local authorized distributor.

(*6) The stated water resistance rating is for when the sensor is connected to the unit. However, this does not include the sensor areas for the RTR-503/503L models. Not for continued immersion.

(*7) Compared to the value measured by the T&D standard sensor for calibration under our calibration light source.

(*8) Up to four digits are valid for the Current Readings and Cumulative Measurements.

(*9) If necessary, serial communication can be established by using our RTR-574 communication protocol to write a software program. In such a case, an optional serial communication cable (TR-07C) is needed. For details please contact the distributor from which you purchased the Unit.

System Setup

Remote Unit

Wireless Data Loggers
(Sensor Included)

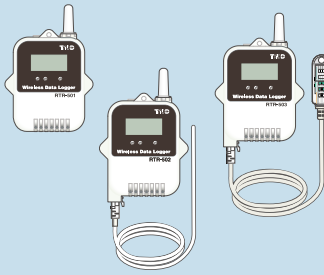

Lithium Battery inserted into a tube (LS14250 (SAFT))
Included

RTR-500A1 External Power Adaptor Kit
Sold Separately

RTR-500B1 * Large Capacity Battery Adaptor Kit
Sold Separately

* When using RTR-500B1 it is necessary to purchase Lithium Battery (LS26500).

AA Alkaline Battery x1
Included

Base Unit RTR-500GSM



AA Alkaline Battery x 4
Included

or
AC Adaptor
AD-0605 or AD-0607

or
External Power Cable
BC-0201
Included

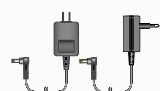

Install



USB Cable (US-15C)



Purchase Extra Items Separately for RTR-500GSM

We do not handle or sell these items.

SIM Card
Required item for operation



External Output / Input Compatible Connector



External Power Supply
Voltage : DC 8-34V
Current : MAX 2A



GPS Receiver



Base Unit / Repeater RTR-500



USB Cable (US-15C)



Use as a Repeater

AA Alkaline Battery x2
Not Included

AC Adaptor
AD-0638 or AD-0638-C

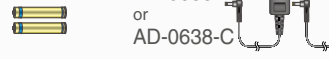

Install Connect

Install Connect

Install Connect

USB Cable (US-15C)

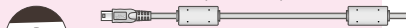

LAN Cable for 500AW (LN-20W)



Software



AC Adaptor
AD-0638 or AD-0638-C

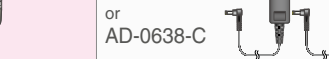

Connect

Install Connect

Base Unit RTR-500DC



USB Cable (US-15C)



AAA Alkaline Battery x2
Not Included

Nickel Hydride Battery x2
Not Included

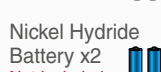

AC Adaptor
AD-0638 or AD-0638-C

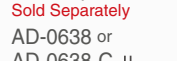

Install Connect

Install Connect



Initial Settings Function Settings

* It is not possible to simultaneously connect more than one Base Unit to a PC.



Some devices such as a hub, wireless LAN access point, server, and so on are sold separately and may be necessary to connect to a local network. T&D does not manufacture or sell these items.



Initial Settings Function Settings

Web Site
T&D Online

For product information, software update and FAQ ;

<http://www.tandd.com/>



Caution regarding safety

For safe operation carefully read instructions before using this unit.

Colors in the photos in this catalog may be different from real product colors. The specifications and designs of the products in this catalog are true as of March 2011. Specifications are subject to change without notice. Microsoft® and Windows® are registered trademarks of Microsoft Corporation USA and other countries. GSM is a trademark of GSM MOU Association. All registered trademarks, company names, product names and logos mentioned herein are the property of T&D Corporation or of their respective owners.

■ Distributor



T&D Corporation

817-1 Shimadachi, Matsumoto, Nagano Japan 390-0852

Please send your inquiries to:

E-mail : sales@tandd.com

Facsimile : (+81) 263-40-3152



2011. 03. 16304590004D